

# CEP 96 THREE-PHASE FOUR QUADRANT kWh METER



Code	Type	Currents (Ib)
M3 0701	CEP-96 (ITF)	In / 5A

## 1.- MAIN FEATURES

Electronics-based, Class 1 rated, electrical energy meter, with 4 lines LCD display and also with backlight, for its use in L.V. three-phase networks. These energy meters are appropriate for any application that requires the monitoring of partial energy consumptions. An additional open collector output can be used as a pulse output.

## 2.- Installation



This manual contains information and warnings that must be followed for operating the ENERGY METER safely and maintaining the instrument in a safe operating condition.

Whether the instrument is not used as manufacturer's specifications, the protection of the instrument can be damaged.



### Mounting:

Instrument is to be mounted on panel (cut-out  $92^{+0.8} \times 92^{+0.8}$  mm, as per DIN 43 700). All connections keep inside the cabinet.

Note that with the instrument powered on, the terminals, cover opening actions or elements removal may allow accessing dangerous parts. The instrument must not be used until this is completely installed.

The monitored line should be provided with a circuit breaker or any equivalent element (fuses) to disconnect the instrument from the power supply network. This switching device must be placed near the instrument and will be easily accessible.

The supply and measuring voltage circuits will be both connected through a wire with a minimum cross-section of  $1 \text{ m}^2$ .

The line of the current transformer secondary will have a minimum cross-section of  $2,5 \text{ m}^2$ .

CEP-96 has a power supply input which is independent from the measuring circuit.

Current measurement actions are done through external In / 5 A current transformers.

## 3.- Screen

CEP 96 has two different screens which show the imported and exported energy. By pressing the  key, you can choose the imported energy (appears kWh on the fourth line) or the exported energy (appears -kWh on the fourth line).

## POWER SUPPLY

230V ac

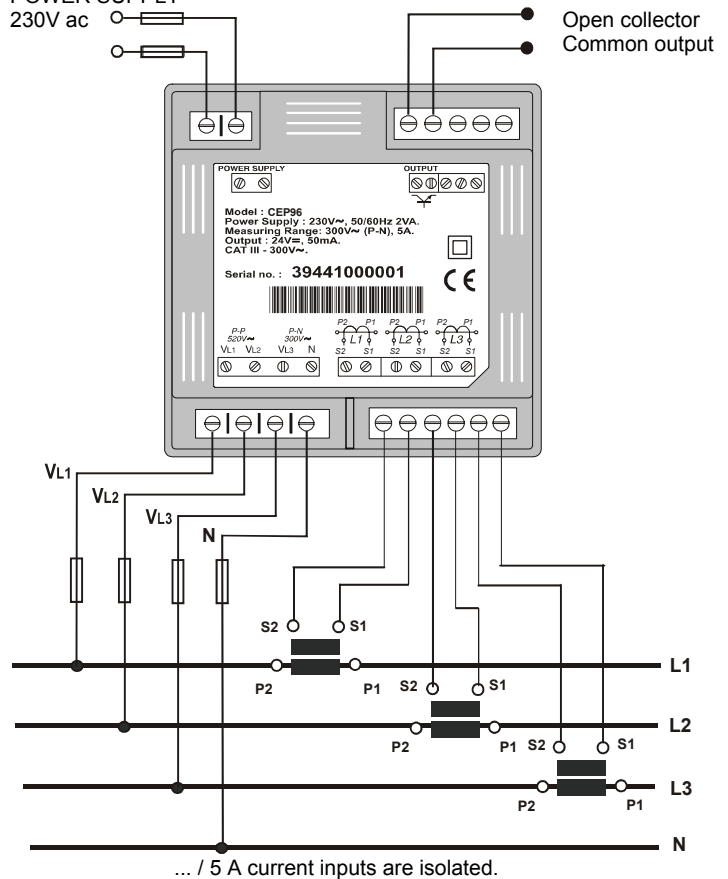

## 4.- SETUP

(Simultaneously press the keys MAX and MIN when working in the main program)

- The key  validates the value and passes to the next menu.
- The key **MAX** permits the user to select among different options in a menu or to increase a digit when a variable is being entered.
- The key **MIN** is used to move the cursor along the digits.

**NOTE :** When you arrive at the last digit, you can move the position of the decimal point with the "max" key.

When accessing SETUP, the following message is shown in screen for some seconds:

(1) **SETUP UNLOC** (SETUP unlocked) : when the SETUP is accessed, configuration parameters can be either visualized and modified.

(2) **SETUP LOC** (SETUP locked) : when the SETUP is accessed, configuration parameters can be visualized but cannot be modified.

Different options are following shown in a sequential mode:

### 4.1.- Voltage Transformer Primary

On the screen we read the word "SET VOLT PRI" followed by 6 digits. They allow us setting the primary of the voltage transformer.

SET  
VOLT  
PRI  
027500

From 1 to 10000V

### 4.2.- Voltage Transformer Secondary

We can now set the value of the secondary of the voltage transformer. Only three digits are available:

SET  
VOLT  
SEC  
001

From 1 to 999V

If the CEP-96 is directly connected to the mains (without voltage transformer) the values of primary and secondary must be the same, for instance 000001/001.

#### 4.3.- Current Transformer Primary

"SET A P" and five digits appear on screen allowing us to set the primary of the current transformer. The current green LEDs light on to avoid mistakes.

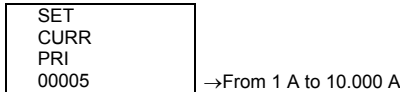

#### NOTE :

- The secondary of the current transformers is not programmable. It is automatically set at 5 A (... / 5 A ac)
- The Voltages transformer and primary current value to be set is also limited by the following condition:

$$\frac{\text{Pr imV} \bullet \text{Pr imCurr}}{\text{SecV}} < 1.900.000$$

- When trying to validate "↵" a value exceeding the maximum allowable value, the screen will blink and the previous value will be saved.

#### 4.4.- Setting preferred page

This option allows the fixed or rotating pages ("SET def Page"):

- Fixed page: selects Import or export screen, that will appear first when applying voltage to the CEP 96 (or on resetting).
- Rotating pages: automatically rotates the pages (every 5 seconds it moves on to the following screen).

#### 4.5.- Setting disconnection time for the backlight

Setting of the period of time to go by, from the moment that the CEP keyboard is not touched anymore, before the CEP's backlight is automatically shut down (low consumption mode):

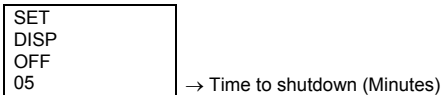

The backlight will be automatically turned on, when any CEP key is pressed. If 00 is set, the backlight is permanently on.

#### 4.6.- Clearing energy counters

On display we see "CLR ENER no" (Clear energy counters).

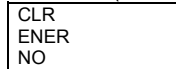

#### 4.7.- Relay Output.

This output is user settable to give a pulse every certain kW.h (Energy). The value of consumed energy necessary to generate an output pulse can be defined (duration of the pulse is 0.5 s): kW.h / 1 pulse.

On the CEP-96 screen following messages appear at this SET-UP point:

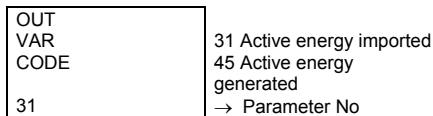

- Press the key "↵" to validate the choice.

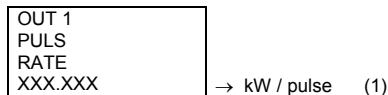

#### 5.- SECOND SET-UP OF THE CEP-96

It is possible to access to a second MENU of SET-UP that allows the configuration of the CEP-96 with other options different of the standard ones. To enter into it proceed as follows:

- Without power supply in the CEP-96, press simultaneously "↵", "max" and "min" keys.
- Keeping these keys pressed, supply the CEP-96. We will read on the CEP-96 screen the following:

#### SETUP lock and unlock



- If the **LOC** option is selected, when accessing SETUP just the configuration can be checked, but not modification is allowed.
- If the previously option is modified, a 4-digit password is requested (if it is not correct, then the value blinks and the previous menu is accessed).

**DEFAULT PASSWORD : 1234**

To exit this section press RESET (WARNING: in case of exit by reset, latest modification might not be saved) or go to the SETUP2 ending.

#### 6.- MAINTENANCE

Before any adjustment, replacement, maintenance or repairing operation is carried out, the instrument must be disconnected from any power supply source.

When any protection failure is suspected to exist, the instrument must be immediately put out of service. The instrument's design allows a quick replacement in case of any failure. In this case contact a qualified service representative.

#### 7.- Specifications

**Power supply : see specifications on the rear part of the CVM-96**

<b>CEP-96</b>	Single-phase	230 V a.c.
	Voltage tolerance:	-15 % / +10 %
	Frequency:	50 ... 60 Hz
	Burden :	4VA
	Operation temperature :	-10 to 50 °C

#### Measuring Circuits :

Rated voltage	300 V a.c. Phase-to-Neutral
	520 V a.c. Phase-to-Phase
Frequency	45 to 65 Hz
Rated current.	In / 5 A (isolated inputs)
Permanent overload.	1.1 In
Minimum measurable current.	1% In
Current input burden.	0.75 VA

**Accuracy : 1 % of readout ± 2 digits**

**Scale range measurement margin: 10 ..... 100 %**

#### Mechanical Characteristics :

Connection :	Pluggable connection terminal
	Metallic terminal with flat headed screw.
Case material	Self-extinguishable, V0 plastic
Protection	Assembled unit (frontal ) : IP 54
	Un-assembled unit (side and rear covers) : IP 31
Dimensions	96 x 96 mm - depth: 63 mm
Weight	0.4 kg

#### Display:

-Type:	LCD (4 lines) with backlight
-Energy unit :	kW·h
-Maximum count:	999.999,999 kW·h

#### Transistor output features

Type:	Opto-isolated transistor (open collector).	NPN
Maximum operating voltage:		24 V DC.
Maximum operating current:		50 mA
Maximum frequency:		5 pulses / second
Energy Output: (default)		100 pulses / kW.h
Length of pulse:		100 ms

#### Safety:

Category III - 300 V AC. / 520 AC. EN-61010 Class II double insulation against electric shock

#### Standards :

IEC 664, VDE 0110, UL 94, IEC 801, IEC 348, IEC 571-1, EN 61000-6-3, EN 61000-6-1, EN-61010-1

#### Dimensions :

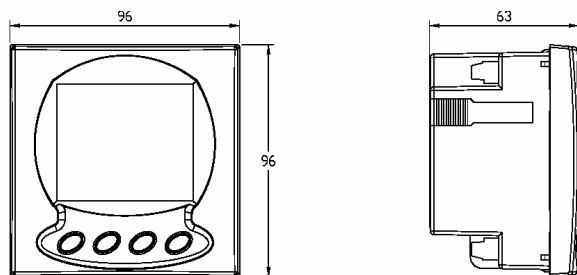

#### 8.- TECHNICAL SERVICE

In the event of any equipment failure or any operational queries please contact the technical service of National Meter:

National Meter Industries, Inc.

Bedford, NH 03054

P - 800.325.6674

email: teach@national-meter.com

www.national-meter.com